



OWNERS MANUAL

SEPTEMBER 24

- ✓ High quality, efficient and energy saving
- ✓ Industry leading technology and innovation

EG_OWNERS MANUAL

EG-260FR



ECOGENICA
INNOVATION MEETS TECHNOLOGY

All-in-one Connection Model EG-260FR



The Ecogenica **EG-260FR** litre All in one Mains Pressure Heat Pump Hot Water Heater, offers a slim line design, with rapid hot water heating and exceptional energy efficiency. This model does not contain an electric heating element.

This water heater is designed for direct connection to mains water supply. In case the mains supply pressure exceeds 500kPa, a pressure limiting valve must be installed. A minimum water supply pressure of 200kPa is required to assure the effective operation of this water heater.



Warning: Safety Information

Please read all manuals carefully before installing and operating this unit. The following safety warnings are very important, always read and obey all safety signs.



WARNING

- The device must be effectively grounded.
- RCBO circuit breaker must be installed.
- Do not remove, cover or damage any permanent instructions or labels from the exterior or interior of the unit panel.
- Only qualified personnel should install in accordance with local and national regulations and this guide.
- Improper installation may cause water leakage, electric shock or fire alarm.
- All electrical connections must comply with the requirements of the local power company, the local power company and this guide.
- Do not use rated fuse, otherwise it may malfunction and cause electrical fire.
- Do not insert fingers, rods or other objects into the air inlet or outlet. The fan is rotating at high speed, which may cause injury.
- Do not use flammable sprays, such as hairspray or paint, near the machine to avoid fire.

- **Disposal:** Do not dispose of electrical appliances as unsorted municipal waste. A separate collection facility should be used. Contact your local government to find out information about the collection system. If electrical appliances are disposed of in landfills or dump sites, hazardous substances can seep into groundwater and cause health problems.

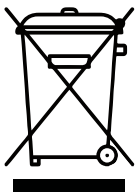

- Make sure there are no obstacles around the device.
- In places with strong wind (such as seaside areas), the unit should be installed in a windproof place.
- The PTR valve should be operated every 6 months to ensure that the valve does not have any restrictions. The drain pipe should be well insulated to prevent the water in the pipe from freezing in cold weather.

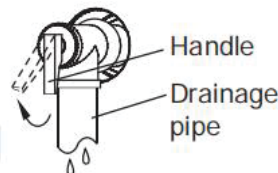

CAUTIONS

- The ground electrode must be well grounded. Make sure all electrical sockets and plugs are dry and tightly connected;
- Before cleaning, be sure to stop operation and isolate the unit (ie, turn off the isolating switch or circuit breaker). Otherwise, electric shock and injury may occur;
- Water temperature over 50 degrees Celsius will cause severe burns and even death. Children, the disabled and the elderly are at the highest risk of burns. In the bath feel the water temperature with your hands before showering to avoid burns.
- Do not operate the machine with wet hands to avoid electric shock.
- A one-way check valve and a suitable isolation valve must be installed on the water inlet side.



- It is normal for the one-way safety valve to release some water during operation. However, if there is a large amount of water, please contact our service team. Improper drainage can cause water damage to surrounding areas such as buildings, furniture etc. Except for repair and maintenance purposes, do not turn off the power, especially in cold weather, as it may freeze the machine when the power is turned off. Continuously powered heating water is necessary.

Do not puncture the water heater casing, do not smoke, or activate sparking of any description within 1.5 meters of this water heater. Compliance with national gas regulations should be observed. This water heater contains flammable propane refrigeration in a sealed closed refrigeration circuit..



Warning: Notice to Customer

The manufacturer's warranty does not cover any damage or defect caused by improper installation, attachment or use for any type of accessories (other than those listed in this user manual) with this water heater. The use of unauthorised energy saving devices may shorten the life of the water heater and may endanger life and cause property damage. The manufacturer disclaims any responsibility for such loss or injury resulting from the use of such unauthorised devices. Check council laws for specific rules in relation to location requirements for this appliance.

Warning: - If the hot water system is not in use for a number of weeks a quantity of hydrogen gas may accumulate in the Water Heater. To dissipate the gas safely please turn on the hot water tap for several minutes to ensure that gas has been properly removed from the water heater. As the air escapes sometimes sounds occur, this is normal.

TEMPERATURE LIMITING VALVE

Ecogenica Pty Ltd requires the installation of a temperature limiting device between the water heater and the hot water outlets in a bathroom or similar usage point to reduce the risk of scalding.

Additionally, a certified plumber may have the legal obligation to ensure the water heater installation meets the hot water delivery requirements listed in AS/NZS3500.4

LOCATION REQUIREMENTS

The water heater and water lines should be protected from freezing temperatures and highly corrosive atmospheres. Locate the water heater in a clean area as near as possible to the areas of the biggest hot water demand. Long uninsulated hot water lines can waste energy and water.

IMPORTANT - INDOOR INSTALLATION APPROVALS: Because this unit draws in ambient air to heat the water, when using the unit indoors, you must contact the manufacturer and seek written approval to ensure that the proposed installation meets Australian Standards and has sufficient clean air to operate correctly.

Place the water heater in such a way that clearance for proper servicing is considered (→section 3.7) namely for top cover removal, PTR valve access and anode rod removal and installation. Remember you may need to remove the entire unit later for servicing.



WARNING

This water heater SHOULD NOT be installed in an area with a corrosive atmosphere where chemicals or flammable liquids are stored or where aerosol propellants are released. When using indoors, because of natural air movement in a room or other enclosed space, these corrosive/flammable vapours can be carried from where they are being used or stored. Any electric arc drawn within the water heater's electronic controls can ignite these vapours, causing an explosion or fire, which may result in severe burns or death to those in range as well as property damage.



CAUTION

The heater should not be in an area where leakage of the tank or connection will result in damage to the area adjacent to it or to lower floors of the structure. In places where installation in such areas cannot be avoided, it is recommended that a suitable catch pan which adequately drains, be installed under.

Warning: Notice to Customer *(continued)*

This installation must comply with the requirements of the AS/NZ3500.4 and AS/NZS3000 standards and all additional local codes and regulatory authority requirements.

In New Zealand, the installation must comply with the clause G12 of the New Zealand Building Code. All packaging materials must be removed from the water heater prior to its installation.

REQUIRED CLEARANCES

There must be a 30cm vertical clearance, a 20cm min clearance between the inlet and the wall, and 100cm from the outlet grilles and walls, or barriers. This will ensure a proper air flow through the appliance and facilitate the service any time is needed.

APPLIANCE OPERATION

In case of possible direct exposure to strong wind, face the air outlet to the most protected area. The direct incidence of strong wind in the outlet grille during long periods may affect the performance of the heat pump increasing the heating times and the frequency of defrost cycles. The use of the noise reduction mode is not recommended in case of moderate or strong wind. Adjust the height to correctly align the appliance at the installation location.

To ensure the faultless operation, the unit must be installed vertically with a tilt no more than 1°, preferably in the direction of the condensate drain to favour the condensates drainage.



WARNING:

**Damage to external tank casing!
Do not tilt more than 20° without packaging.**



WARNING:

All plumbing work must be carried out by a qualified professional and in accordance with the Plumbing Standards AS/NZS3500.4 & local authority requirements.

INLET-OUTLET CONNECTIONS

Installation of the water inlet or outlet pipes: The water inlet and outlet thread are $\frac{3}{4}$ BSP (internal thread). Pipes must be heat resistant, durable and UV resistant (when doing outdoor installation). Installation of the pipe for PTR valve: The specification of the valve thread is $\frac{1}{2}$ BSP (internal thread). Note: one way valve must be installed at the inlet.

POWER REQUIREMENTS

Check the markings on the rating plate of the water heater to be certain the available power supply corresponds to the water heater requirements. The Heat Pump Water Heater must be directly connected to a 230V-240VAC 50Hz mains power supply.

The water heater Heat Pump must be installed on separate individual circuits with a RCBO breaker switch installed directly at the switchboard. The appliance must be powered for the first time during the purge procedure after the tank was filled with water.

The hot water heat pump supply must be protected by a separate RCBO on the main switchboard and rated to suit the size of the components. Do not connect other appliances, especially high powered appliances, to main power supply of the water heater to ensure it operates with out interference.

FR MODELS :these models can be installed on a shared circuit however,care must be taken by the licensed electrician to ensure that the shared circuit is not overloaded.

SOLAR POWER

The Heat Pump also comes with a Solar activation timer. Solar Power must be provided to the inverter and switch board, as per local regulations and Solar installation Standards. The timer ensures that the Heat Pump operates between daylight hours, to align with Solar Power production. Users of the Heat Pump should use the Application to engage Solar timer activation, or disengage the timer, if Solar Power isn't available, during rainy, or Winter Months, for example. For instruction on Solar Timer Activation see the Ecogenica website or contact Ecogenica directly.

Connections

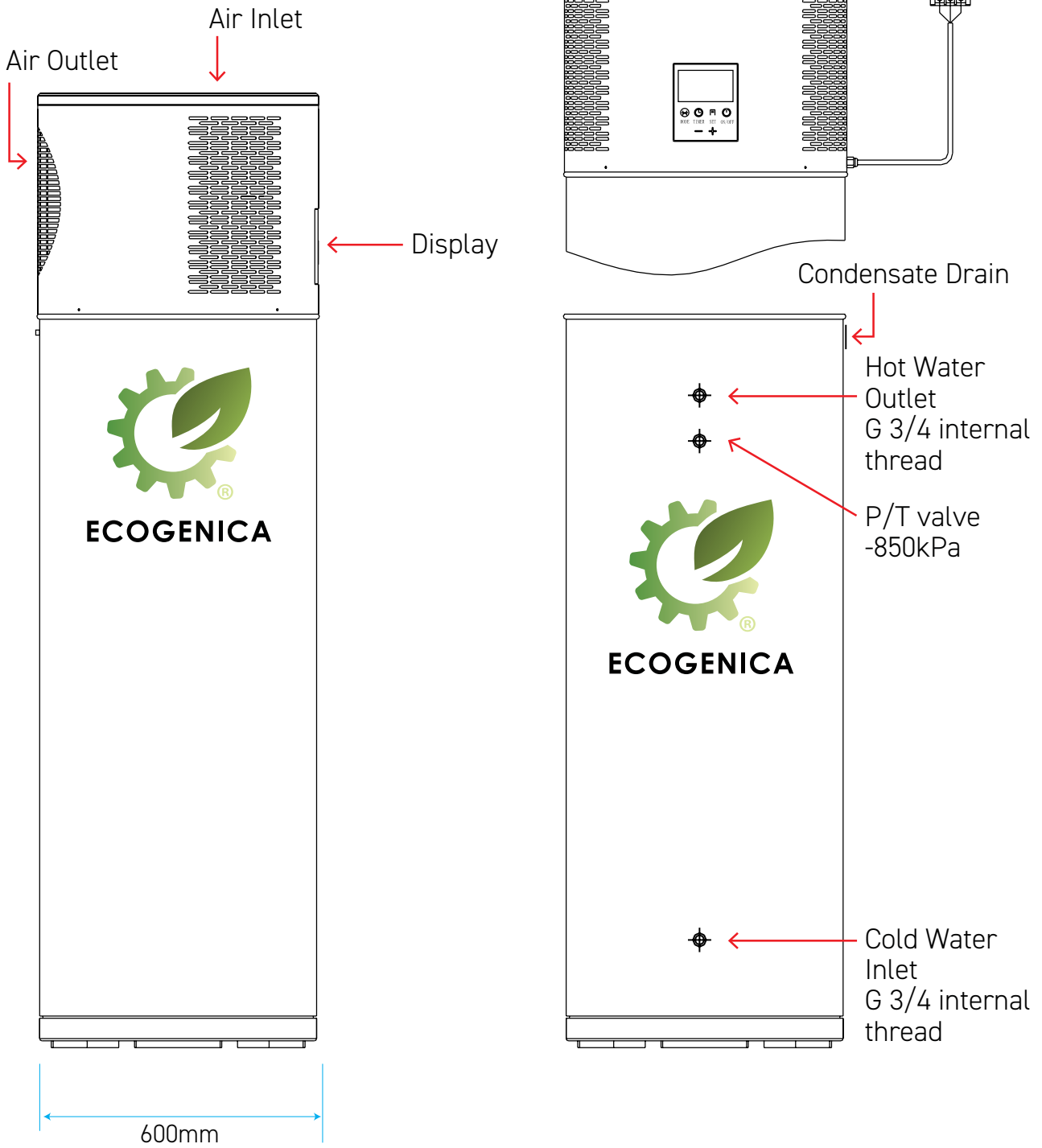

Electrical Circuit Diagram

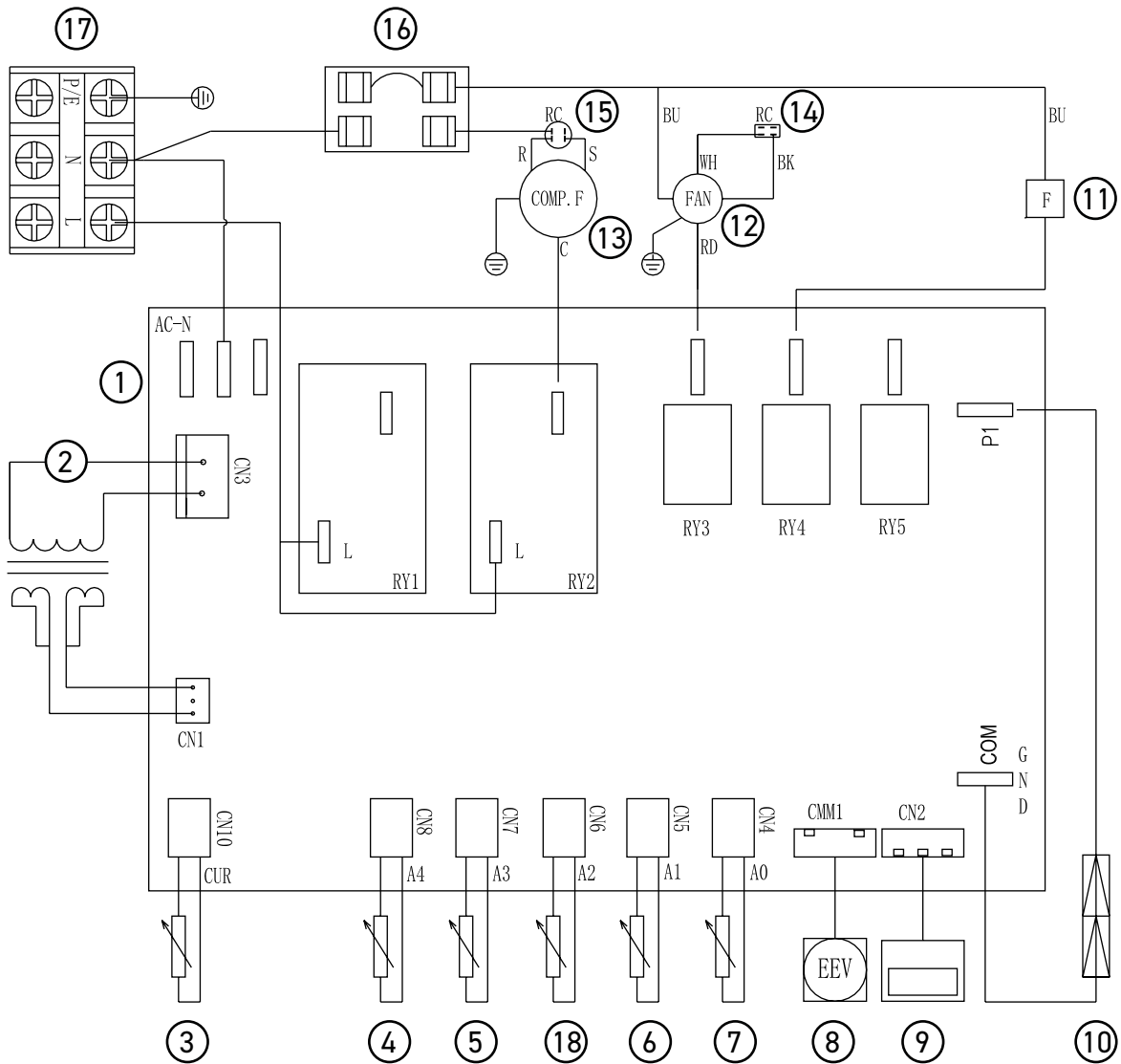

- 1 - Integrated Circuit Board
- 2 - Transformer
- 3 - Exhaust Temperature Sensor
- 4 - Gas Recovery Temperature Sensor
- 5 - Coiler Temperature Sensor
- 5 - Water Tank Temperature Sensor T1
- 7 - Ambient Temperature Sensor
- 8 - Electronic Expansion Valve
- 9 - Display

Installation

10.1 PIPING CONNECTIONS

Installation of the water inlet or outlet pipes:

The water inlet and outlet thread are 3/4 BSP (internal thread). Pipes must be heat resistant, durable and UV resistant (when doing outdoor installation).

Installation of the pipe for PTR valve: The valve thread specification is 1/2 BSP (internal thread)

Note: one way valve must be installed at the inlet.

All pipe work should be insulated with proper insulating material (weatherproof and UV resistant if exposed) to optimise energy efficiency.

To ensure the faultless operation, the unit must be installed vertically with a tilt no more than 1°, preferably in the direction of the condensate drain in order to favour the condensates drainage.

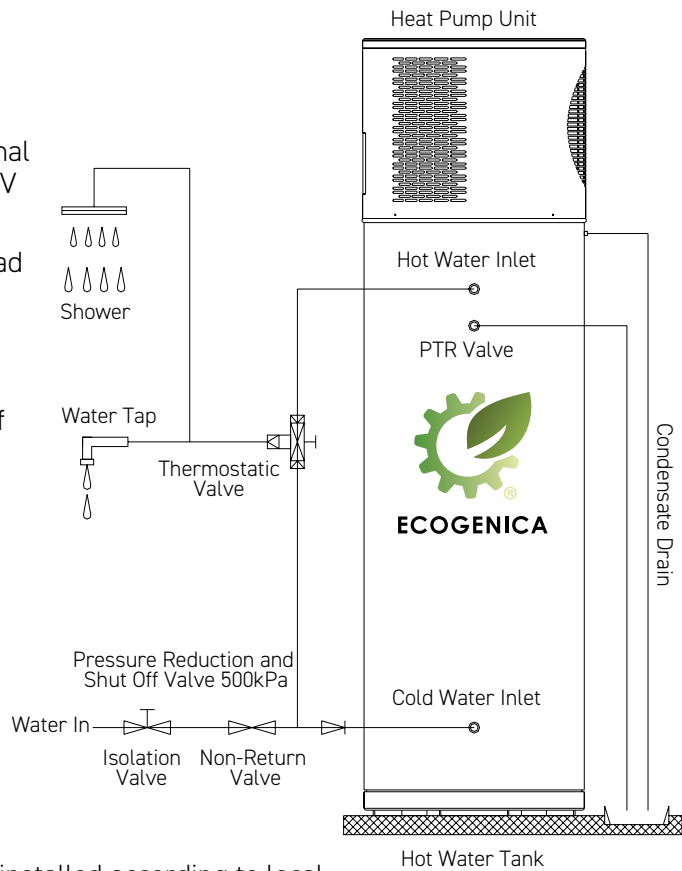

CAUTIONS

The temperature and pressure-relief valve must be installed according to local code. Not doing so will cause damage to the appliance and to other property.

The function of the temperature and pressure relief valve once installed on this water heater is to discharge high conditions. Therefore, it is strongly recommended that the pipe work connected to the relief valve is able to withstand water temperatures exceeding 99°C. Failure to follow this recommendation may result in a dangerous situation.

DIELECTRIC JOINT

Different metals between plumbing and tank materials and additionally the effect of hot water can cause the corrosion of one of the metals (generally the one in the tank is the metal attacked).

The dielectric joint will basically avoid any physical contact between the two metals, acting as an effective insulator and prevent this attack. How quickly this, or it at all, happens, depends a lot on the content of your water. It's pH, the dissolved minerals and the metals involved.

CONDENSATE DRAIN TUBES

This unit has an integrated condensation tray. The water collected in the tray drains out of the tube. It is important that a hose is attached to drain.

WARNING: - Never block or seal the outlet of the PTR valve or its drain for any reason. The warranty will be void if the relief valve or other safety devices are tampered with or if the installation is not in accordance with this manual.

Installation *(continued)*

THERMAL EXPANSION TANK

Thermal expansion is a natural process where heated water increases its volume. When this water is stored in a tank, this volume increase will in fact mean a pressure increase. This pressure increase can result in a dangerous situation. If the safety settings on the relief valve are reached, then the relief valve will operate during the heating cycle.

Please contact a licensed professional, water supplier or plumbing inspector for information about this subject.

PTR Valve

A temperature and pressure relief valve is supplied and must be installed in the tank port marked for this purpose. No valve or accessory of any type should be installed between the relief valve and the tank. Please observe local codes for the correct installation of relief valves.

The kW rating of the relief valve must be higher than 6kW to ensure that is always above the maximum output power of the water heater when operating with both electrical heater and heat pump and air at 40°C. The supplied PTR valve complies with this by having a power capacity of 10kW.

Connect the outlet of the relief valve to a suitable open drain so that the discharge water cannot contact any electrical parts, persons or animals and to eliminate any other possible risks.

Always use a valve of the same rated pressure and temperature as the PTR valve supplied with the unit.



WARNING

The pressure rating of the relief valve must not exceed 850kPa, the maximum working pressure of the water heater as marked on the rating plate.

Relief valve easing gear should be operated. If water does not discharge freely when the lever is operated, the valve should be checked by an authorised agent.

The relief valve and relief valve drain pipe must not be sealed or blocked. Small amounts of water may leak from relieve valve during heating cycles.

Installation *(continued)*

TEMPERATURE MIXING DEVICE

Ecogenica Pty Ltd recommends the installation of a temperature limiting device between the water heater and the hot water outlets in a bathroom or similar usage point in order to reduce the risk of scalding.

PRESSURE LIMITING VALVE

This water heater is designed for direct connection to mains water supply. In case the mains supply pressure exceeds 850kPa, a pressure limiting valve must be installed. The pressure rating of the relief valve must not exceed 500kPa, the maximum working pressure of the water heater as marked on the rating plate.

A minimum water supply pressure of 200kPa is required to assure the effective operation of this water heater. In installations where the mains water supply pressure exceeds that specified for this product, an approved pressure limiting valve is required and must be fitted. If the water is supplied with low pressure water, below the minimum working pressure for this product, then a pressure pump should be installed in order to minimise the forming of air traps in the hydraulic circuit.

EXPANSION CONTROL VALVE

A saturation index greater than +0.4 or in corrosive water areas where there are sufficient quantities of silica dissolved in the water may require the installation of an expansion control valve (ECV) in the cold water line, being the last valve installed prior to the water heater.

ELECTRIC REQUIREMENTS

Check the markings on the rating plate of the water heater to be certain the available power supply corresponds to the water heater requirements.

This water heater must be directly connected to a 230V-240VAC 50Hz mains power supply. When connected off grid, please make sure the 230V-240VAC 50Hz true sine wave power supply is available.

Do not connect to inverters providing square sine waves.

The water heater must be installed on its own circuit with a RCBO breaker switch installed directly at the switchboard.

To ensure the faultless operation, the unit must be installed vertically with a tilt no more than 1°, preferably in the direction of the condensate drain in order to favour the condensates drainage.

The appliance must be powered for the first time during the purge procedure after the tank was filled with water.



Warning

Proper ground connection is essential. The presence of water in the piping and water heater does not provide sufficient conduction for a ground. Nonmetallic piping, dielectric unions, flexible connectors etc, can cause the water heater to be electrically isolated.



1 Installation *(continued)*

Plumbers – Best Practice is required please conduct the following check list before you finish and ensure that Valves easily accessible and all drainage doesn't damage buildings.

Check your drains and piping for the following:

- 1. Drains are directed away from building footings,
- 2. Fall continuously from the valve to the point of discharge,
- 3. Does not pose a risk of injury to people,
- 4. The drain line discharges water away from the operator during the operation of the valve. Refer to AS/NZS 3500.4:2021 Section 5.11,
- 5. Copper piping is used, and you cannot use plastic pipes for drain lines, (AS/NZS 3500.4:2021, 2.5.2 (g)),
- 6. The drain lines are insulated for at least the first 500mm, note that these drains are still considered an "outlet" according to the definitions in the standards.

Specification Table

Model	EG-260FR
Tank capacity	260
Capacity	3.25
Description	Integral_All In One
Refrigerant	R290
Fittings	20mm/3/4 BSP Inch
Application	Residential
Set Point*	60
Element	/
Design Temp*	Range:-15 to 45
Condenser	Improved micro channel
Compressor	700 Watt/Rotary
COP/Efficiency*	4.85
Gas connection	Factory welded
Ocean mark*	OMK32183
Water Mark*	WM-032183
Power	15AMP

System Operation

DISPLAY

1 - **Disinfection:** When the unit is in disinfection mode, the Disinfection icon will be displayed on screen. Disinfection occurs once a week and heats the water to more than 60°C for 30 minutes.

2 - **Motor fan:** Feature not required.

3 - **E-heater:** Only available in FR models.

4 - **Defrosting:** When the device enters the defrost state, the defrost icon will be displayed on the screen.

5 - **Heating water:** When the machine is turned on, the icon of heating water will be displayed on the screen.

6 - **Controller locked:** When the machine is turned on, the icon will be displayed on the screen for child protection. Press start button 4 times to disengage.

7 - **Sensor:** The icon will display on the screen water temperature at the mid point sensor.

8 - **Water temperature setting.** When the control panel will display the current required temperature at the mid-point sensor; when setting the required temperature, the water temperature will change accordingly.

9 - **Clock:** The clock will be displayed all the time. When in clock setting mode, the clock will show the setting time, outside of this mode the clock will display the current set time.

10 - **Time on:** If a TIME ON timer has been set, the TIME ON icon will be displayed on screen.

11 - **Alarm lamp:** If the device fails, the alarm indicator lamp will display with error code.

12 - **Time off:** If a TIME OFF timer has been set, the TIME OFF icon will be displayed on screen.

13 - **Set key:** See Page 34. And we recommend you contact your service agent for assistance.

14 - **Turning the unit ON:** Make sure the water tank is full of water before starting the machine. To turn on the unit, unlock the control panel and press and hold the on / off button for 3 seconds.

Turning the unit OFF: To turn off the unit, unlock the control panel and press and hold the on / off button for 3 seconds.

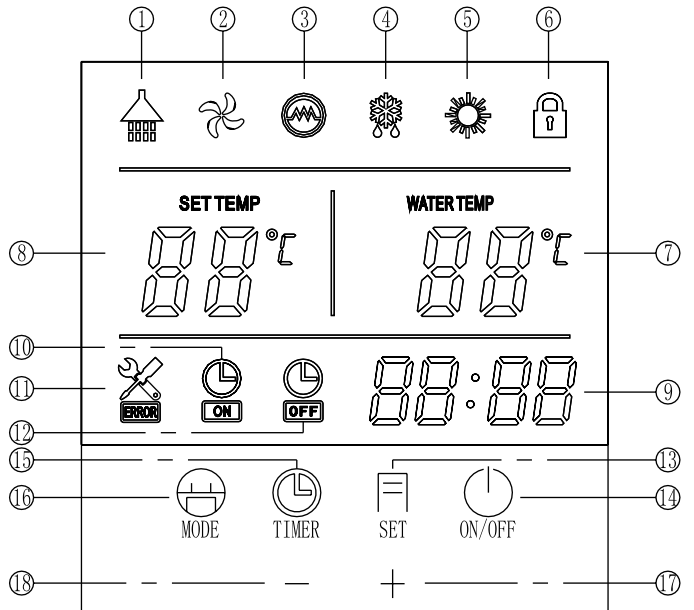

15 - **Setting the TIME ON Timer:** If the timer is set to time on, the unit will automatically run once between the clock setting and the last 24 hours.

16 - **Start the electric heating mode;** Not available in this model.

17 - **Increase:** To raise the temperature, unlock the control panel and continue pressing the "+" button. Set the clock. To increase the time, press the "+" button. When querying parameters, enter the query set function, and press the "+" key to view various operating parameters. When setting parameters, enter the setting function, and press the "+" key to view various setting parameters.

18 - **Decrease:** To reduce the temperature, unlock the control panel and continue to press the "-" button. Set the clock. To shorten the time, press the "-" button. When querying parameters, enter the query function, and press the "-" key to view various operating parameters. When setting parameters, enter the setting function, and press the "-" key to view various setting parameters.

11.2 BUTTON COMBINATION FUNCTIONS

13+15 Press simultaneously:

Forced defrost mode:

Press and hold the key combination for 5 seconds to enter the forced defrosting mode.

13+16 Press simultaneously:

Reset parameters: |

In the shutdown state, press the key combination for 3 seconds to reset the parameters. The reset is successful, and the buzzer rings for 2 times.

WARNING: DO NOT OPEN

Only Ecogenica licensed technicians should open our units

System Trouble Shooting

TROUBLE SHOOTING

DISPLAY	DESCRIPTION	SOLUTION
E1	Protection of high pressure switch	Switch off power and reconnect. If this fault occurs frequently, please contact the authorised contractor
E3	Electric overheating protection	Water tank is short of water or protection fails please contact the authorised contractor
E7	Compressor exhaust temperature high temperature protection	During heating operation, when the ambient temperature is higher than $>35^{\circ}\text{C}$. Compressor exhaust temperature is greater than 115°C hours The pump host will automatically shut down for protection. The operation panel displays E7. When the compressor exhaust temperature is lower than 95°C . The water tank is restored.
E8	Communication failure	The communication line is disconnected or the display screen is damaged.
P1	Water tank temperature sensing fault	Notify authorised contractor.
P3	Evaporator temperature sensor error	Notify authorised contractor.
P4	Compressor suction temperature sensor error	Notify authorised contractor.
P5	Ambient temperature sensor error	Notify authorised contractor.
P7	Compressor discharge temperature sensor error	Notify authorised contractor.

NOTE

The diagnostic codes listed above are the most common.

If a diagnostic code not listed above is displayed, please contact for technical assistance.

For all Models

System Maintenance

CLEANING

The heating effect depends on whether there is dust, mud or other on the surface of the evaporator. Sundries block the air inlet channel and lose the effect of heat exchange with the air, resulting in heating efficiency.

Customers are required to ensure that the heat pump remains clean and free from debris.



Before
Cleaning

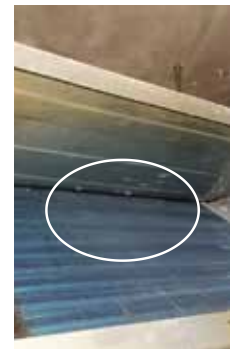

After
Cleaning

CHECK THE ANODE

It's essential to replace the anode, when necessary, as the anode is installed in your water heater to protect the cylinder, but it will slowly wear out over time. It is recommended that you replace the anode during a five-year service, or before if you have poor water quality in your area, the maximum time between replacement is 8 years. Poor water quality occurs when water supplies that are either softened, desalinated, or where the water supply alternates between a water tank and a public supply or another source.

Typically, a magnesium anode is fitted as the standard option. During anode replacement the correct selection of the anode is crucial to maintain the warranty on the water heater cylinder.

- Turn off the heat pump unit (disconnect the power supply directly)
- Turn off the stop valve ① and turn on the stop valve ⑤ and faucet to drain the tank
- Locate the anode position and unscrew the anode cover
- Use an Allen wrench to loosen
- Check the consumption of the anode, if it is used up, it needs to be replaced immediately, so as not to affect the quality of the water
- To restore the state of use, be sure to fill up the water first and observe whether there is any leakage
- Turn on the power, turn on the heat pump to heat the water to the termination temperature, and then observe whether there is any leakage here, before leaving.

WEEKLY DISINFECTION

- The high-temperature disinfection will be opened automatically at 2 a.m. once a week (it can be opened in thermostatic shutdown and standby state). It will stop when the T tank is \geq TS3 (parameter 04), and start when the T tank is \leq TS3-2. Keep the water temperature T1 between TS3-4 and TS3 for t2, and exit the procedure after t2, reset the timer, and enter the timing of next week. When the disinfection procedure has been operated for more than 3h, the disinfection will be exited forcibly.
- Note: During disinfection, the digit light in the main interface flashes for prompting.

System Maintenance *(continued)*

PTR MAINTENANCE

Periodic operation of the valve is recommended to ensure smooth water flow.

If the water does not flow freely, change valve.

In order to avoid the expansion and deformation of the water tank due to excessive pressure, the service life of the water tank will be affected.



- Find the position of the valve
- Carefully release the valve with the lever to release some water from the tank.
Note: Please use the water discharged from the container to avoid damage to other items
- If the water is flowing, the valve is still in proper working order
- If the water does not flow freely, the valve is out of function and needs to be replaced
- If the valve needs to be replaced, please contact your plumber or our service team for further assistance.

CHECK

Please check the machine regularly for any damage, if there is obvious damage, please contact our maintenance team. In some cold areas (below zero degrees Celsius), if the system stops working for a long time, all the water in the water tank should be released and re-installed in the water tank.

Reuse before filling with water to prevent the inner box from freezing.

Failure to do so may cause the machine to malfunction and, in severe cases, damage.

WATER QUALITY REQUIREMENTS FOR WATER SUPPLY (chloride and pH)

IMPORTANT

In areas of water supplies with high chloride levels, water can corrode certain parts, causing them to fail. It is not suitable for heat pump units and storage tank units if the chloride content exceeds 200 mg/L. pH is a measure of whether water is alkaline or acidic.

Heat pump units and hot water tank units with a Ph value less than 6.0 are not guaranteed.

The water supply to rainwater storage tanks within urban agglomerations can be corrosive due to the dissolution of atmospheric pollutants.

Water with a pH value of less than 6.0 can be treated to increase the pH value, so it is recommended to analyze the quality of tap water before connecting to this type of water supply system.

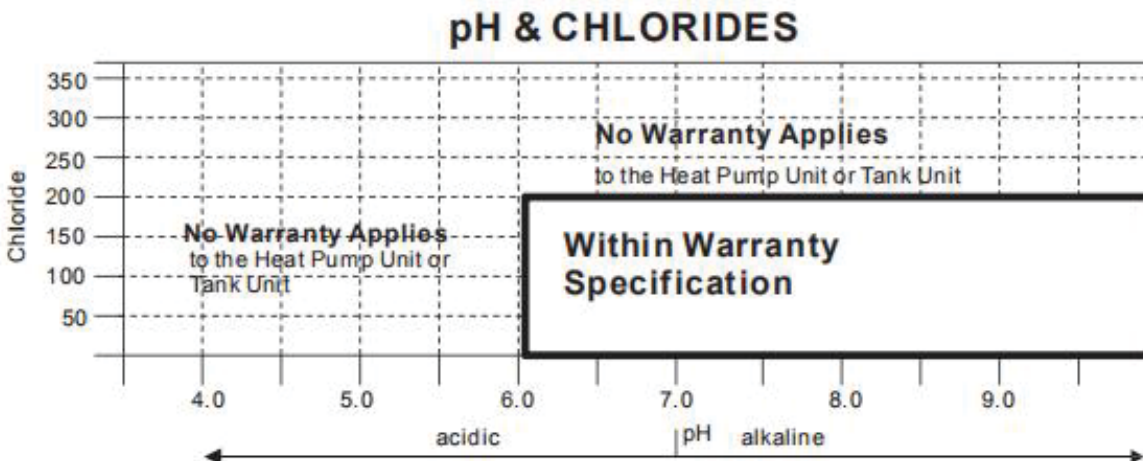

Warranty

Disclaimer: All our Heat Pump systems must be installed by a licensed and certified installer ensuring all local, state and national regulations are met. Failure to do so will void this warranty.

NOTICE TO CUSTOMER

Our goods come with guarantees that cannot be excluded under the Australian Consumer Law. You are entitled to a replacement or refund for a major failure and compensation for any other reasonably foreseeable loss or damage. You are also entitled to have the goods repaired or replaced if the goods fail to be of acceptable quality and the failure does not amount to a major failure.

Note: We recommend all consumers safely store receipts, invoices, warranties, and any installation records to allow for faster processing of warranty claims.

11 TERMS OF WARRANTY

1. The warranty terms in this Ecogenica Customer Product Manual FRE relates only to the Ecogenica FRE/FREC Range of Heat Pump Water Heater System, namely:

EG-260FR models.

The warranty period are as follows from the date of installation:

- 7 Years warranty for the Tank, 5 Years warranty for the Compressor and 2 years for Servicing.
- 2 years for parts and all Labour costs associated with diagnosis, removal of the faulty part, and installation of replacement parts. After 2 years this will solely be the owner's responsibility and cost.

The benefits conferred by this Warranty are in addition to all other rights and remedies in respect of the Heat Pump Water Heater System, which the purchaser has under the law including the Competition and Consumer Act 2010 and consumer protection legislation of the States and Territories. Nothing in this Warranty has the effect of excluding, restricting or modifying those rights.

2. Ecogenica will repair or provide parts for repair or replacement, where defects arise from faulty materials.
3. Ecogenica is responsible for reasonable costs associated with legitimate warranty claims, as determined by Ecogenica. To determine whether a warranty claim is legitimate, Ecogenica may send an Ecogenica accredited service agent to inspect the product. Ecogenica is not responsible for:
 - (a) any costs that are not pre-approved in writing by Ecogenica; and
 - (b) any costs associated with a product which is determined upon inspection not to be covered by this warranty.

Any reasonable costs incurred by the consumer that is associated with making a legitimate warranty claim will be reimbursed by Ecogenica.

Inquiries relating to warranty coverage and claims for Ecogenica products or services must be made by contacting Ecogenica.

An Ecogenica accredited service agent or the Ecogenica service department can repair or replace product components, subject to Ecogenica terms and conditions of warranty. Ecogenica can, in addition, provide information on operation and maintenance of Ecogenica products. Ecogenica contact details are on the back of this document.

12 WARRANTY CONDITIONS

1. The person making the claim must be the owner of the Product or have written authorisation to act on behalf of the owner which must be provided to Ecogenica.
2. The person making the claim must notify Ecogenica as soon as they notice any defects without delay, and the product must be within its warranty period as set out in the terms of warranty.
3. The warranty applies to products manufactured on or after the date of publication of this warranty.
4. The terms of warranty take effect from the date of completion of installation of the Product and full payment of the Product. Ecogenica reserves the right to request proof of purchase or a copy of the certificate of compliance (this is required by law to be issued by the installer) to verify the date of completion of installation prior to commencing any warranty work. Where the date of completion of installation is not known, then this warranty will commence 2 months after the date of manufacture. The date of manufacture is stated on the data plate of the appliance.
5. Prior to any inspection, service, repair or replacement undertaken pursuant to the warranty on a Heat Pump Water Heater System, the following must occur:
 - a. The warranty works must be authorised by Ecogenica; and
 - b. Proof of purchase and the certificate of compliance must be submitted to Ecogenica.
6. The Heat Pump Water Heater System must be installed, commissioned, serviced, repaired and removed in accordance with the installation instructions supplied by Ecogenica for the Heat Pump Water Heater System, and in accordance with all relevant statutory and local requirements of the state/province/municipality in which the Heat Pump Water Heater System is installed.
7. All Heat Pump Water Heater Systems must be operated and maintained in accordance with the Ecogenica operating instructions.
8. The warranty only applies to the Heat Pump Water Heater System and original or genuine (company) component replacement parts provided by Ecogenica. The warranty does not cover any plumbing or electrical parts supplied by the installer and that is not an integral part of the Heat Pump Water Heater System. Such parts would include, but is not limited to, pressure regulating valve, limiting valves, check valves, tempering valves, electrical switches or fuses.

9. To the extent permitted by law, Ecogenica shall not be liable under this Warranty for any consequential loss or damage or any incidental expenses resulting from any breach of this warranty, including but not limited to, claims for damage to buildings, roofs, ceilings, walls, foundations, gardens, personal belonging or household effects, fixtures and fittings, or any other consequential loss, damage or inconvenience, either directly or indirectly due to the Heat Pump Water Heater System or component(s) related to the system or its operation including but not limited to leakage.
 10. Where a failed component or Heat Pump Water Heater System is replaced under warranty, the balance of the original warranty period will remain effective. The replaced part or Heat Pump Water Heater System does not carry a new warranty.
 11. Ecogenica reserve the right to have the installed product returned to the factory for inspection.
 12. Products eligible for repair may be replaced by refurbished goods of same type rather than being repaired. Refurbished parts may be used to repair/replace the Products.
 13. Where the Heat Pump Water Heater System is not installed in accordance with the installation instructions or installed in a position that does not allow safe, ready access as determined by the attending service person, the service may be refused at their discretion. Any cost to access the site safely, including the cost of additional materials, handling and/or safety equipment, will be charged to the consumer and will be the consumer's responsibility.
 14. The Heat Pump Water Heater System must be sized to supply the hot water demand in accordance with the guidelines in the Heat Pump Water Heater System Literature.
- 13 WARRANTY EXCLUSIONS**
- Products supplied by Ecogenica are subject to warranties that cannot be excluded by law. Any breach of condition or warranty is limited to the repair or replacement of the Product, the supply of an equivalent Product, the payment of the cost of repairing or replacing the Product or acquiring an equivalent as determined by Ecogenica.
- Repair and replacement work will be carried out as set out in the Heat Pump Water Heater System terms of warranty. However, the following exclusions may void the warranty and may incur additional service charges and/or cost of parts:
15. Damage to the Heat Pump Water Heater System or any component, including accidental damage, natural disasters, acts of God, storm damage, vandalism.
 16. Failure due to abuse, misuse or neglect, improper maintenance, or failure to maintain and incorrect or unauthorised installations.
 17. Failure or damage caused by alterations, service or repair work carried out by persons other than Ecogenica accredited service agents or the Ecogenica service department.
 18. Where no fault is found with the Heat Pump Water Heater System or its components and the issue is related to the plumbing installation or is due to a direct or indirect failure of water, electric or gas supplies, corrosive atmosphere or other issues not caused by a fault of the Product including but not limited to:
 - (a) excessive discharge from the temperature and/or the pressure relief valve due to high water pressure.
 - (b) excessive water pressure.
 - (c) no flow of hot water.
 - (d) water leakage.
 - (e) where the supply of electricity or water does not comply with relevant codes or acts, or the power supply is cut;
 - (f) the overflow vent drain has not been installed or it is blocked or corroded.
 - (g) rust due to a corrosive atmosphere.
 19. Where the unit fails to operate or fails because of excessive cold or ice formation in the piping to or from the Heat Pump Water Heater System.
 20. Where any faults arise from connecting to a water source that is unfiltered such as dams, bores, rivers etc.
 21. The Heat Pump Water Heater System being relocated from its original point of installation.
 22. Operating the water heater and components when not filled with water.
 23. This warranty applies to Heat Pump Water Heater Systems connected to the energy source listed on the data label of the Product.
 24. This warranty does not apply to damage caused by sludge and/or sediment in the water supply.
 25. Repair and/or replacement of the Heat Pump Water Heater System due to scale formation above 200ppm. (water hardness) in the waterways or the effects of either corrosive water or water with a high chloride or low PH level when the water heater.
 26. Where the Ecogenica Heat Pump Water Heater System is in a position that does not comply with the Heat Pump Water Heater System installation instructions or relevant statutory requirements, causing the need to dismantle or remove cupboards, doors, or walls, or require the use of special equipment to bring the Heat Pump Water Heater System to floor or ground level or to a serviceable position.
 27. Labour costs incurred due to an Ecogenica accredited service agent performing checks which should have been carried out by the consumer in accordance with the operating instructions and where no defect is found.

“Water heating is the second largest source of greenhouse emissions accounting for almost a quarter of household energy use.”



ECOGENICA

Your new ECOGENICA® W-Series series heat pump uses a small amount of energy to move heat from one location to another. Heat is absorbed by ozone-friendly R290, a natural refrigerant which does not contribute to global warming.

We support the Australian government in its commitment to transforming our energy supply system into one that is cheap, clean and reliable.

This lays the foundation for future generations to enjoy more secure, reliable and affordable energy.

You can choose an ECOGENICA® product safe in the knowledge that our innovative technology is focused on energy and environment savings. Our hot water pumps are cfc free and utilise renewable energy, extracted from the air.

CONTACT US:

CALL: 1300 341 010

VISIT: ecogenica.com.au

6 Braeside Drive, Braeside, Vic, 3195 Australia

ECOGENICA® —A smart choice for the environment a smart choice for you